



Glass roof systems

Murano Puro
Murano Vetro
Murano Integrale
Murano Integrale Z
Murano Glissando
Murano Finestra

Murano Glass Roofs



Just
enjoy life!

Lewens
MARKISEN





A cleverly conceived roof and a system to match

The glass roofs in the Murano series feature a variety of designs and configuration options: compact and modern or traditional with roof overhang, laterally flush or recessed, as a glass roof pure and simple with integral awning or integral zip awning for wall-to-wall shade. Complementary sliding glass panels and permanent glazing along with a host of comfort features complete the range.

All model developments from the Lewens company are inspired by the latest trends and requests or ideas from customers and retailers. They come with highly developed technology, functionality and design.

Lewens' awnings and glass roofs are manufactured in a fully integrated operation, extending from the design and making up of the fabric to assembly, on a site covering over 30000 m². High-grade materials, intelligent design and precision in cutting and parts production, together with computer-aided automation in the manufacturing process, form the basis for products distinguished by their extreme reliability. Consultancy and sales are entrusted to competent retailers, along with installation and on-site servicing. This creates proximity to the customer and ensures optimal service, so that our customers can just enjoy life!



Quality "made in Germany":

*all awnings and glass roofs from Lewens
are manufactured in Germany.*

Just
enjoy life!





Murano Puro

4

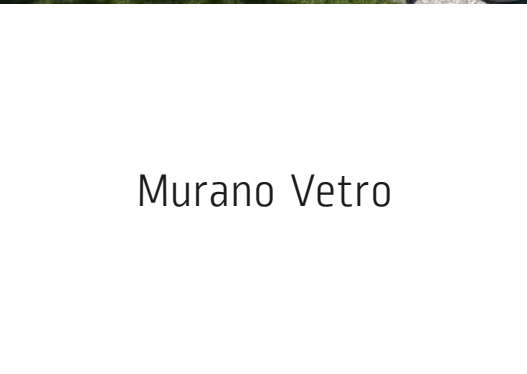

Murano Vetro



6



8



Murano Integrale



Murano Integrale Z



10



12



Murano Glissando

Sliding glass panels



Murano Finestra

Permanent glazing



15

Contents

Models

Murano Puro – the basic model	4
Murano Vetro A perfect retreat from the weather	6
Murano Integrale Optimal protection with integral awning	8
Murano Integrale Z Glass roof with integral zip awning	10
Murano Glissando Sliding glass panels: flexible weather protection and optional triangular infill	12
Murano Finestra Permanent glazing - for the ultimate in protection	15

Equipment

Quality and technology Focus on function and workmanship	16
Comfort options Electrics and wireless	17
Fabrics and colours Fabric collection and choice of frame colours	18
Technical data at a glance	20

To match

Ancona, Portofino, Capri, Micro 2020, Micro 4000 Z, Micro 700 Glass roof, vertical and side awnings	25
--	----



*Murano Puro
creates additional living space and prolongs the patio season.*

Murano Puro – glass roof

Weather protection for small and medium-sized patios

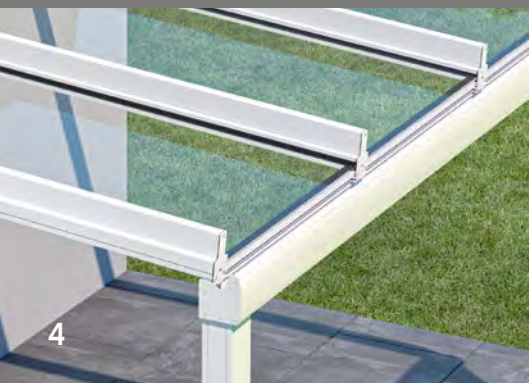

Flush type (B)

with front-facing posts

*The posts are in line with the gutter
for a compact, modern look.*

*Rainwater is drained via the rafters,
gutter and down the inside of the post.*

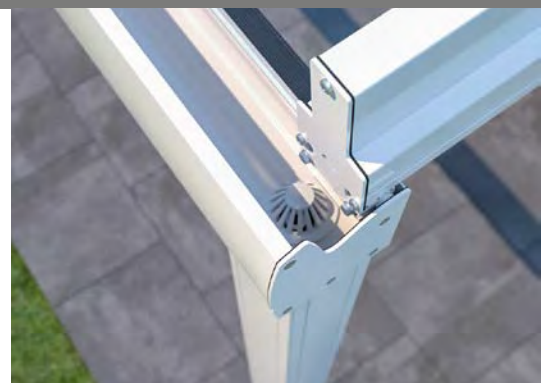

- Width max. 700 cm, depth max. 350 cm
- With 2 to 3 posts
[depending on load and type]
- Optional roof pitch: 3° to 10° (stepless)
- Options: LED lighting, radiant heater



The essence of outdoor living: the Murano Puro glass roof offers a sturdy, versatile and attractively priced option for extending the living space. The posts are in line with the gutter, maximising the area under cover and turning even small patios into a really comfortable nook. Practical detail: the downpipe is integrated invisibly into the posts.

Glass joint with trim in frame colour for dividing the glass panes

Pure and simple:
Flat-ended rain gutter



Slender rafters give the Murano Puro an elegant appearance. Rafter spacings up to 120 cm wide permit the use of large glass panes *[depending on roof size and load]*.



*Murano Vetro Flush type
with posts and gutter in a line.*

Murano Vetro – glass roof

The perfect retreat from the weather for large patios

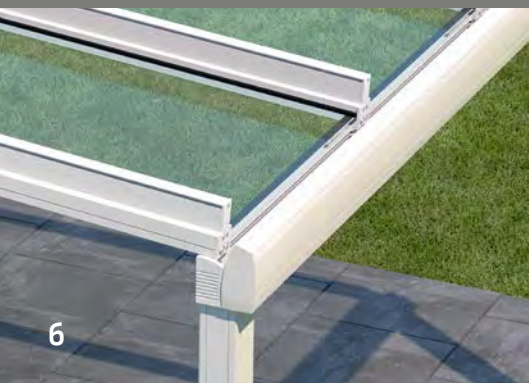

6

Flush type (B)

with front-facing posts

*The posts are in line with the gutter
for a compact, modern look.*

*Rainwater is drained via the rafters,
gutter and down the inside of the post.*



Made to measure with centimetre accuracy

- Width max. 700 cm, depth max. 500 cm
- With 2 to 3 posts *(depending on load and type)*
- Optional roof pitch: 3° to 20° [stepless]
- Options:
LED lighting,
radiant heater

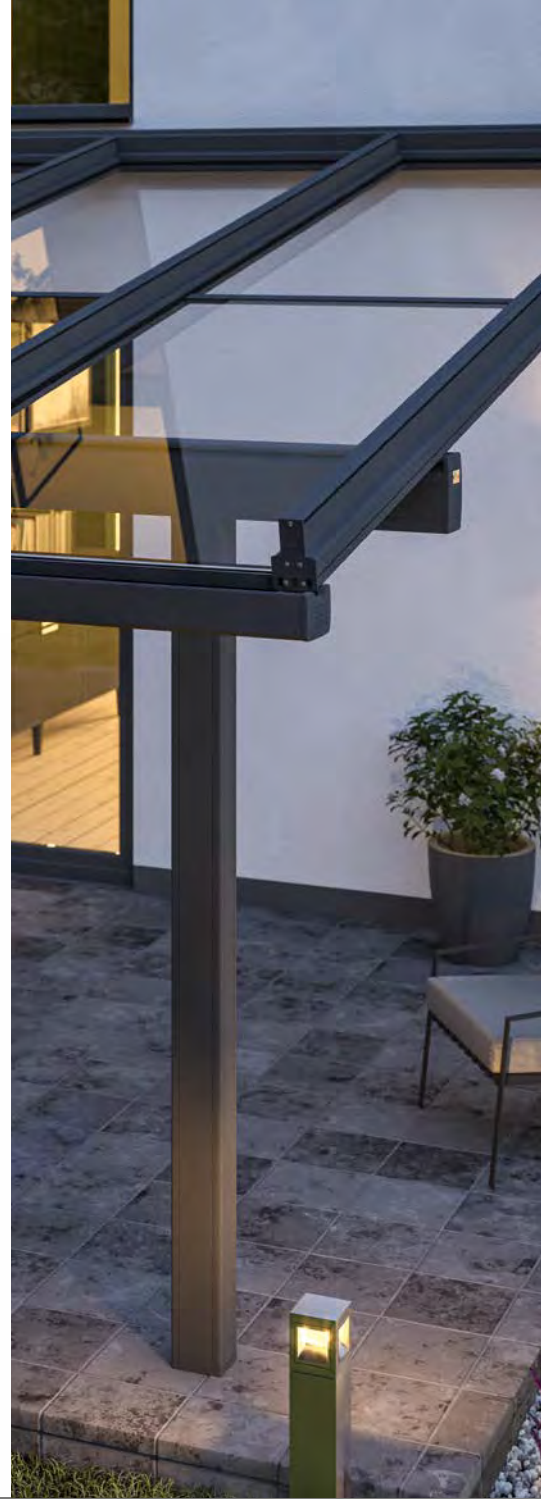

The Murano Vetro glass roof provides protection from the weather at any time of the year, thus extending the patio season. The elegant structure can be installed relatively easily on virtually any patio and its generous maximum dimensions make it suitable even for wide expanses. A choice of types and styles is available with posts that are in line with the front profile and positioned laterally flush or inwards.

III. top: Overhang type with posts positioned laterally inwards (style Ü).

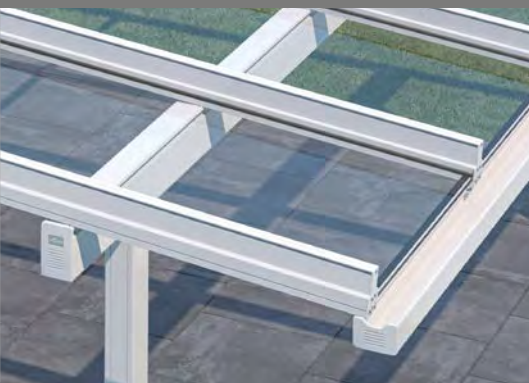

Overhang type (Ü)

with recessed posts

Here the posts can stand e.g. on the patio with the roof overhang taken out over them. Rainwater is drained via a water spout (standard) or optionally via a stainless steel rain chain or downpipes.





*Murano Integrale Overhang type
with laterally flush posts
(style Ü)*

Murano Integrale – glass roof with awning

Optimal protection with integral sunshade



Overhang type (Ü)

with recessed posts

Here the posts can stand e.g. on the patio with the roof overhang taken out over them. Rainwater is drained via a water spout (standard) or optionally via a stainless steel rain chain or downpipes.



Customised protection from the elements

- Width max. 700 cm, depth max. 500 cm
- With 2 to 3 posts *(depending on load and type)*
- Optional roof pitch: 3° to 20° (stepless)

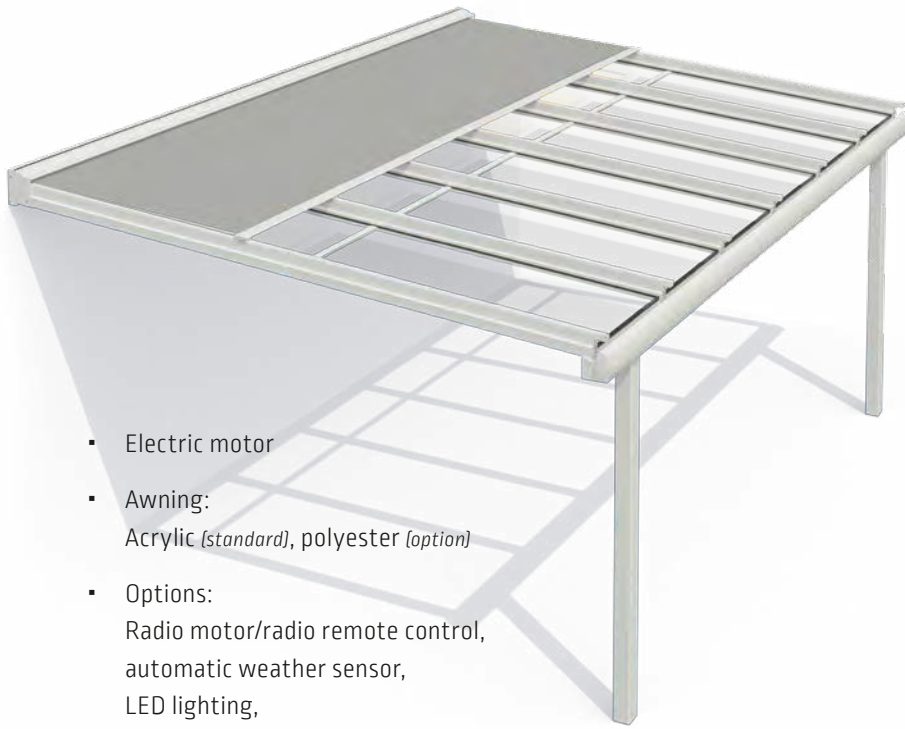

- Electric motor
- Awning:
Acrylic *(standard)*, polyester *(option)*
- Options:
Radio motor/radio remote control,
automatic weather sensor,
LED lighting,
radiant heater



Murano Integrale offers variable shelter from the rain, the temperature and the sunlight. With an awning integrated into the wall profile, this model combines the transparency and protection of a glass roof with the advantages of a high-quality awning for adjustable shade from the sun. Various types and styles with posts in line with the front profile and flush or positioned inwards laterally are available to choose from, even for this generously proportioned glass roof.

*Flush type
with laterally recessed posts
(style B2).*

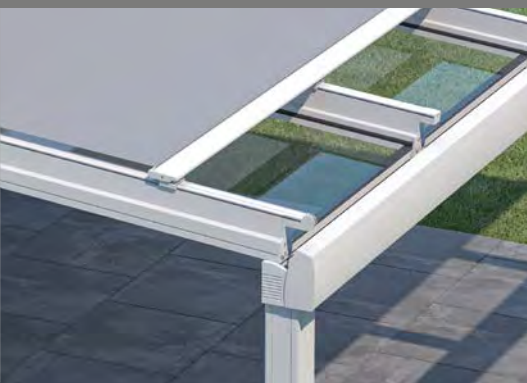

Flush type (B)

with front-facing posts

The posts are in line with the gutter for a compact, modern look. Rainwater is drained via the rafters, gutter and down the inside of the post.





Murano Integrale Z

Glass roof with integral zip awning



Overhang type (Ü)

with recessed posts

Here the posts can stand e.g. on the patio with the roof overhang taken out over them. Rainwater is drained via a water spout (standard) or optionally via a stainless steel rain chain or downpipes.



Bespoke weather protection

- Width max. 700 cm, depth max. 500 cm
- With 2 to 3 posts *[depending on load and type]*
- Optional roof pitch of 3° to 20° *[stepless]*
- Zip guide and patented balance spring technology



- Electric motor
- Awning fabric: acrylic *[standard]*, polyester *[option]*
- Options: Radio motor/radio remote control, automatic weather sensor, LED lighting, radiant heater

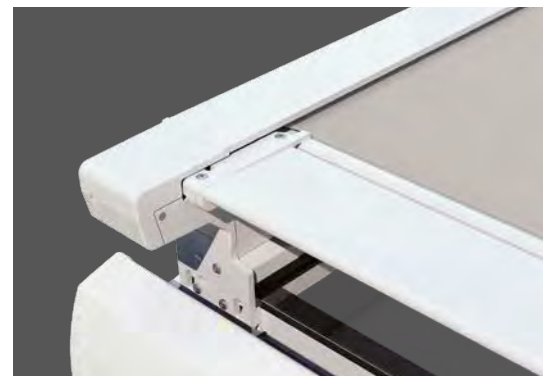

Fabric guide

ZIP (Z)

Tracks with a lateral zip guide and patented balance spring technology ensure a taut sit of the fabric and complete protection from the sun.

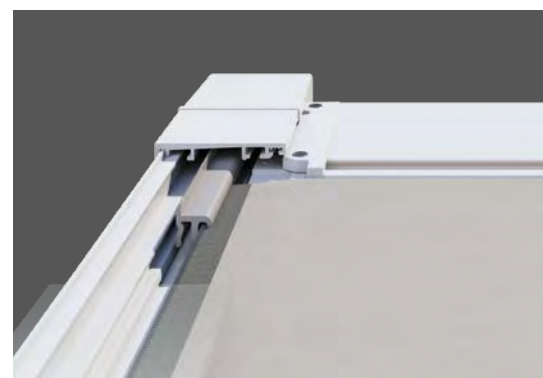

Enjoy the patio at any time of the year and in any weather: the Murano Integrale Z glass roof with integral zip awning offers the perfect all-weather protection, even for large patios. It embodies the ultimate in quality and convenience and features a zip guide and patented balance spring technology. These ensure that the awning on the Murano Integral Z is always ideally tensioned and offers complete protection from the sun without any intrusive light gaps at the sides.



Flush type (B)

with front-facing posts

The posts are in line with the gutter for a compact, modern look. Rainwater is drained via the rafters, gutter and down the inside of the post.





All-round glazing

*Murano Vetro glass roof with sliding glass panels:
Side-opening type on the side walls, 4-track with 4 panels,
Centre-opening type at the front, 2-track with 4 panels.
Equipped with optional triangular infill
with glass retaining strips (type A).*

Murano Glissando – sliding glass panels

Flexible, customised weather protection



Side-opening type

All glass panels are slid to one side left or right for opening. Depending on the desired width and height, 2, 3, 4 or 5 sliding panels can be mounted on 2, 3, 4 or 5 tracks.

Tailor-made comfort

- For glass roofs and permanently modified wall niches
- For all types and styles of Murano glass roofs from Lewens
- Max. width:
Centre-opening type 1150 cm,
Side-opening type 580 cm
- Wall height max. 260 cm
(with single-pane safety glass 10 mm)
- Options:
Lock,
wall connection profile,
triangular infill

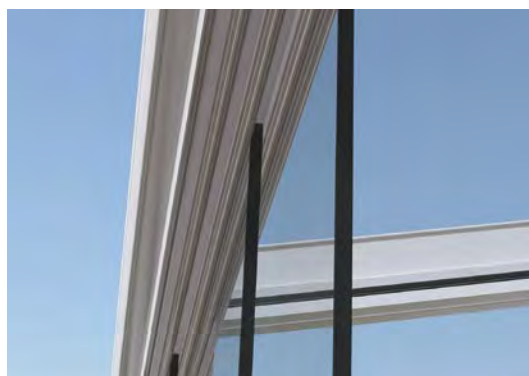

Shapely recessed handles

for smooth opening and closing of the sliding panels.

A transparent rubber trim closes the gap on the centre-opening type.



Good guidance:

A prerequisite for the installation of sliding elements on the side walls of the glass roof is a support profile (triangular infill/ Finestra inclined element).



Triangular infill (option)

The triangular opening remaining can be glazed optionally to prevent the ingress of wind and weather above the side walls. (Here: type B with glass retainer clips)

Murano glass roofs can be fitted with sliding glass side walls offering protection from the wind and weather. The glass walls consist of 2 to 10 upright glass panels creating a transparent wall. Concealed ball-bearing rollers guarantee virtually silent running.

Centre-opening type

The panels are slid apart to the left and right for opening. Depending on the desired dimensions, 4, 6, 8 or 10 sliding panels can be mounted on 2, 3, 4 or 5 rails.





Glass retaining strips *(Type A)*

The glass is attached flush with the surround and virtually invisibly using glass retaining strips at the top and bottom. An air gap remains underneath the box/cassette as well as a gap relative to the wall and eaves.



Glass retainer clips *(Type B)*

A visually attractive, almost "floating" attachment that leaves a gap open around the glass.

Option Triangular infill

The support profile required for the installation of sliding glass elements is used to attach the top running rail. It leaves a triangular opening in the upper area below the glass roof, which can be glazed optionally to prevent the elements from encroaching above the side walls.

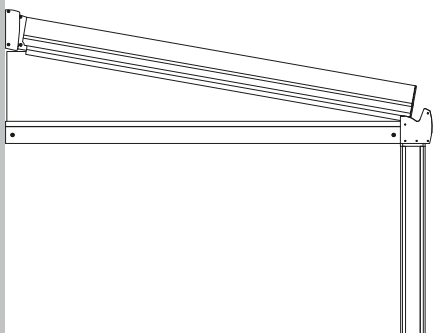

Virtually invisible:
*Triangular infill with
glass retaining strips*

"Floating" attachment:
*Triangular infill with
glass retainer clips*

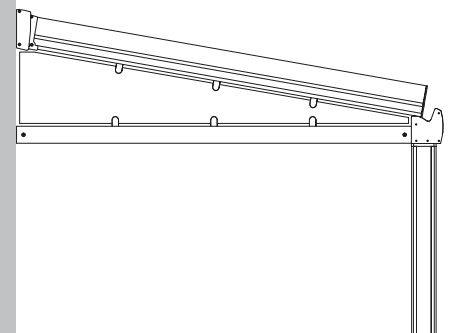

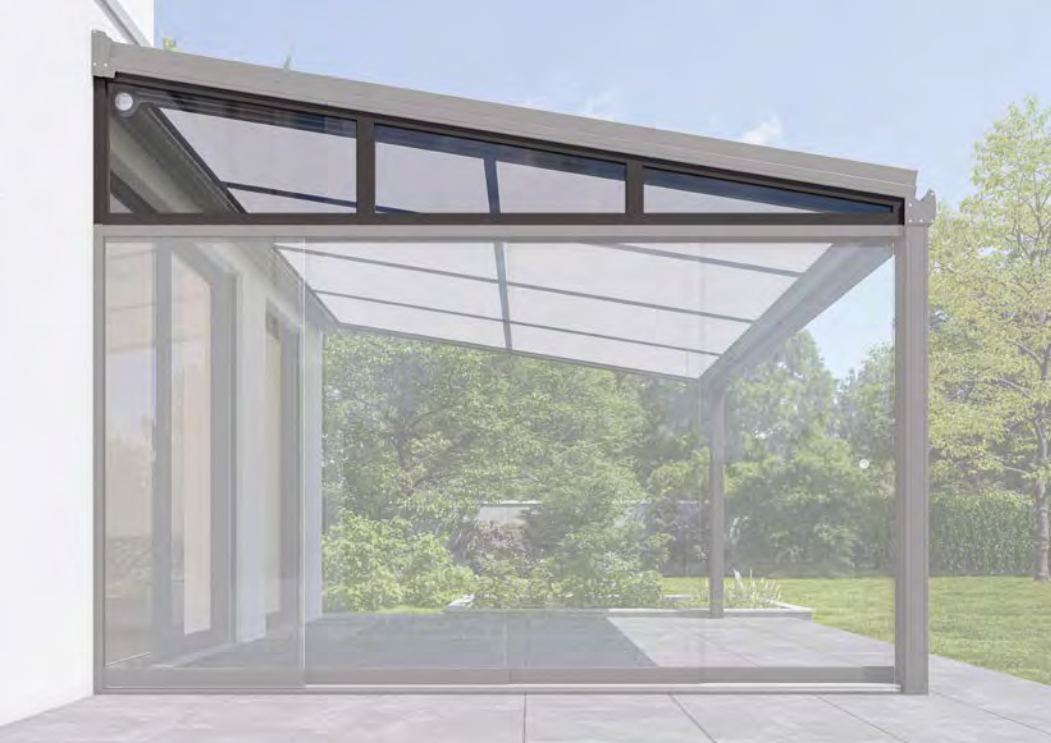

Inclined section type

for permanent glazing of side walls

Can be used to close the space between the roof and side glazing without any gap.

Below this, either rail systems for Glissando sliding glass panels or permanent rectangular glazing can be installed.



Rectangular type

for permanent glazing of rectangular spaces

The solution for glazing down to the ground at the front and back of the glass roof ...

... and as a complement to the inclined section on side walls for

complete glazing

of entire glass roof sides.

Murano Finestra Permanent glazing

Permanent glazing is the best way to achieve maximum protection from wind, weather and draughts. This can be realised as partial glazing of individual wall sections or complete glazing of entire walls up to 500 cm wide.

Seamless connection

Glass frame profiles border the glass panels all round and perfectly enclose the space between the glass roof and vertical glazed panels.

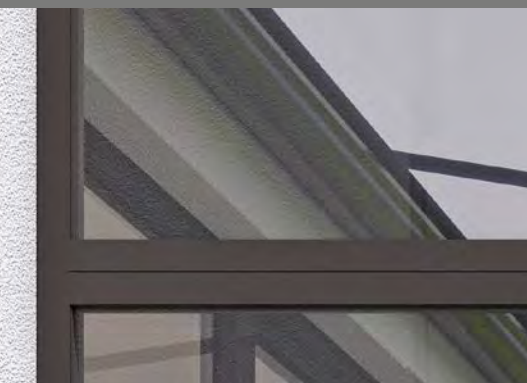

Guaranteed quality



TÜV-tested quality and CE standard:

Look out for the seal and the mark guaranteeing the technical safety of our products.



TÜV-tested quality and CE standard:

Look out for the seal and the mark guaranteeing the technical safety of our products.

Flush with the wall:
imperfections can be compensated for smoothly on assembly



Glass joint
*With divided glass panes, the so-called glass joint is concealed by trims in the frame colour and thereby turned into a decorative element.
The position of the glass joint (division of the glass panes) is optional.*



ZIP fabric guide
(Murano Integrale Z)
Rails with a lateral zip guide and patented balancing spring technology ensure unbroken shade from the sun and perfect tensioning of the awning,

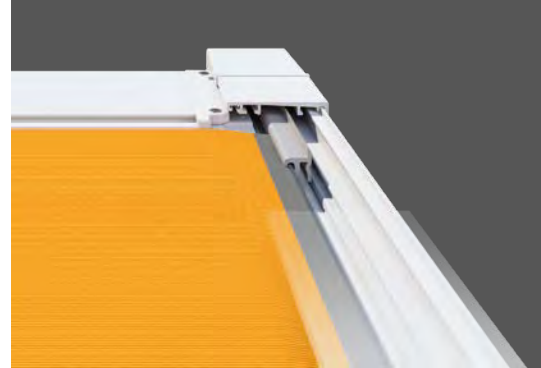

Quality and technology made in Germany

Thanks to their clean, modern design, quality and a variety of equipment options, glass roof systems from Lewens make a convincing impression. Centimetre-accurate manufacturing, even in intermediate sizes, ensures a perfect fit in virtually any desired location.



Award-winning quality

For its Murano Integrale Z glass roof Lewens received the Plus X Award in the categories „High Quality“, Design, Ease of operation and Functionality.



Radio controllers in io technology from Somfy

create the prerequisites for integrating all patio functions into the home automation system (TaHoma, Connexoon), with convenient operation by tablet or smartphone.



Automatic weather sensor

Sun and wind monitors and wind sensors to io standard ensure automatic, weather-dependent control of awnings – even when there's no one at home.



Infrared radiant heaters

to io standard create a cosy atmosphere and pleasant warmth under awnings and glass roofs, even on chilly days.



Options

Electrical

Want more than the wall switch for operation and other comfort features too? Then you have the choice of radio control systems, lighting, radiant heater and automatic weather sensor components meeting the contemporary Somfy io standard, which can all be integrated into the home automation system (TaHoma, Connexoon). All patio functions can thus be conveniently operated via tablet or smartphone.



LED lighting

Equipped with a radio receiver for io technology (option), suitable mood lighting for any situation can be created by remote control or via the home automation system.





Standard RAL colours *at no extra charge*:



Textured finishes *at no extra charge*:



Frame colours to order

The frames of Lewens glass roofs and awnings are given a high-grade powder coating, rendering them particularly UV- and weather-resistant. An optional preanodising treatment increases the durability of the coating for products used in coastal regions. Hundreds of RAL colours and textured finishes are available to choose from, including a wide range of contemporary colours offered as standard at no extra charge.



Preanodising [optional]:

An optional preanodising treatment increases the durability of the coating for products used in coastal regions in particular. This can be selected when ordering.

Colour deviations are possible due to the printing process used.

With well over 300 designs to choose from, the Lewens collection offers you high-quality, spun-dyed acrylic and polyester fabrics that retain their colour brilliance for a long time. Semi-transparent, glass fibre woven screen fabrics and Soltis 92 complete the range, which features modern and classic designs, solid colours, fine textures and 3D effects across the entire colour spectrum.

Lewens awning fabrics have been created especially for use outdoors and are treated to make them water- and dirt-repellent. We make the awnings up using the latest sewing techniques for distortion-free seams and also using ultrasonic bonding. We have designed our manufacturing facility so that the awning fabrics can be laid out entirely flat (not folded) for making up.

Some of our quality features:

- Secure lockstitch used for making up, optionally also with ultrasonically bonded seam (surcharge).
- Awning and valance are produced from one piece (identical repeat pattern)
- Seams on top and bottom and valance seam neatened (clean completion)
- Repeat-symmetrical completion left and right
- Use of Tenara® quality sewing yarn (also for valances)

The Collection

Fabrics ranging
from modern to classic

*For vertical awnings as a complement to the glass roof, **glass fibre woven screen fabrics** are recommended to provide shade from the sun and glare while affording a view outwards.*



Murano Puro | Vetro

Equipment and technical features



Manufactured and assembled in Germany
TÜV-tested safety
Quality and technology CE-compliant

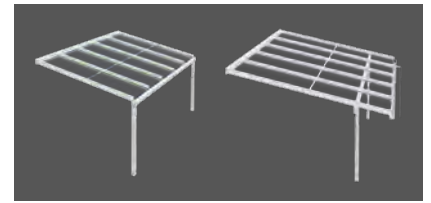

Styles	Murano Puro Flush (B) Type	Murano Vetro Flush (B) Type	Murano Vetro Overhang (Ü) Type
	B1, B2, B3	B1, B2, B3	Ü1, Ü2, Ü3
– Posts laterally external	B1	B1	Ü1
– Posts laterally recessed	B2	B2	Ü2
– with 3rd support	B3	B3	Ü3
– Overhang <i>(inner edge of post – outer edge of gutter)</i>	–	–	30 - 100 cm
– Reinforcement: steel [s]/Murano Vetro gutter [v]	... V	... S	... S
Dimensions (max.)			
Width, 1 unit <i>(single field)</i>	700 cm	700 cm	700 cm
Depth <i>(type B: to inner edge of post; type Ü: to outer edge of gutter)</i>	350 cm	500 cm	500 cm
Pitch angle, stepless <i>(at least 5° recommended)</i>	3° - 10°	3° - 20°	3° - 20°
Rafter spacings <i>(max., depending on type, roof size, load)</i>	120 cm	120 cm	120 cm
Post height 240 cm	■	■	■
Longer posts	□	□	□
Rainwater drainage			
Downpipe integrated into post	■	■	–
Downpipe, external in front of post	–	–	□
Water spout <i>(1 item)</i>	–	–	■
Glazing			
for laminated safety glass <i>(LSG, clear)</i> or twin-wall sheets	!	!	!
Frame colours			
17 RAL colours + 6 textured finishes <i>(Lewens standard colours)</i>	■	■	■
Additional RAL, special colours and effect finishes	□	□	□
Options			
Lighting - LED strips	□	□	□
Radiant heater <i>(only wall attachment)</i>	□	□	□
Glass joint	□	□	□
Additional drainage <i>(downpipe integrated into post)</i>	□	□	–
Rain chain/additional water spout or downpipe	–	–	□
Lateral connection profile/various profiles/support frame	□	□	□

Possible dimensions and restrictions along with the complete range of electronic accessories can be found in the technical data in the current Lewens price list.

■ Standard □ Option – not available
! Not included in scope of supply

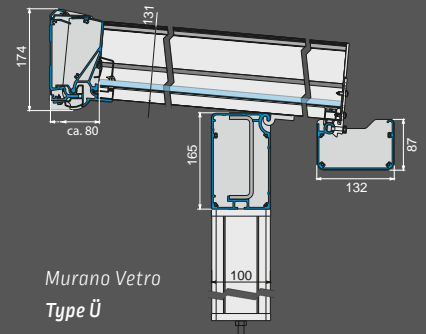
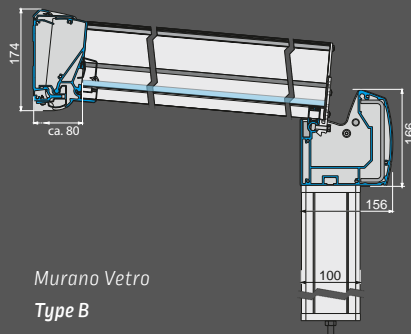
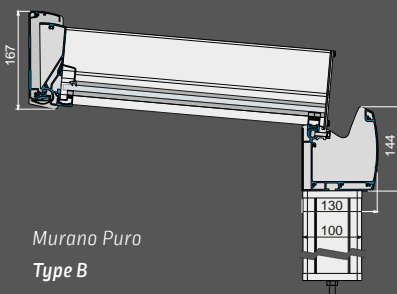

Murano Integrale

Equipment and technical features

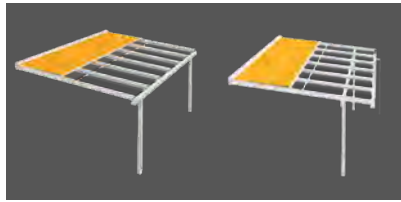

Styles	Flush (B) Type		Overhang (Ü) Type	
	B1, B2	B3	Ü1, Ü2, Ü3	Ü3
– Posts laterally external	B1		Ü1	
– Posts laterally recessed	B2		Ü2	
– with 3rd support	B3		Ü3	
– Overhang <i>(inner edge of post – outer edge of gutter)</i>	–		30 - 100 cm	
– Reinforcement: steel (s)	... s		... s	
Dimensions (max.)				
Width, 1 unit <i>(single field)</i>	700 cm		700 cm	
Depth <i>(type B: to inner edge of post; type Ü: to outer edge of gutter)</i>	500 cm		500 cm	
Pitch angle, stepless <i>(at least 5° recommended)</i>	3° - 20°		3° - 20°	
Rafter spacings <i>(max., depending on type, roof size, load)</i>	120 cm		120 cm	
Post height 240 cm	■		■	
Longer posts	□		□	
Rainwater drainage				
Downpipe integrated into post	■		–	
Downpipe, external in front of post	–		□	
Water spout <i>(1 item)</i>	–		■	
Glazing				
for laminated safety glass (LSG, clear) or twin-wall sheets	!		!	
Drive				
Electric motor (for wall switch)	■		■	
Radio motor (io)	□		□	
Frame colours				
17 RAL colours + 6 textured finishes <i>(Lewens standard colours)</i>	■		■	
Additional RAL, special colours and effect finishes	□		□	
Awning fabrics from the LEWENS collection				
Branded acrylic <i>(spun-dyed, ultra fade resistant)</i>	■		■	
Branded polyester <i>(spun-dyed, ultra fade resistant)</i>	□		□	
Tenara quality sewing yarn	■		■	
Corner reinforcement and lateral seam <i>(10 cm)</i>	■		■	
Options				
Radio motor + radio remote control (io)	□		□	
Automatic weather sensor (sun, wind, rain)	□		□	
Lighting - LED strips, LED spot bar	□		□	
Radiant heater <i>(only wall attachment)</i>	□		□	
Glass joint	□		□	
Additional drainage <i>(downpipe integrated into post)</i>	□		–	
Rain chain/additional water spout or downpipe	–		□	
Lateral connection profile/various profiles/support frame	□		□	

Possible dimensions and restrictions along with the complete range of electronic accessories can be found in the technical data in the current Lewens price list.

■ Standard □ Option
– not available

! Not included in scope of supply

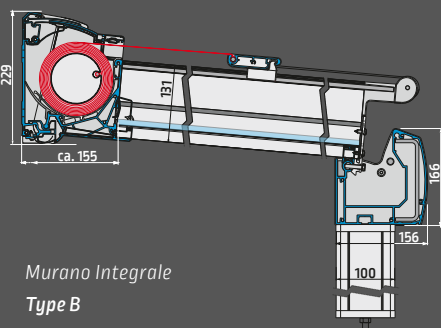

Murano Integrale
Type B

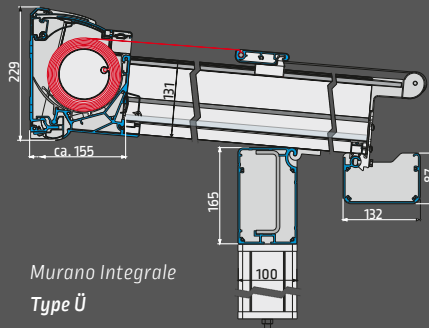

Murano Integrale
Type Ü

Types and styles

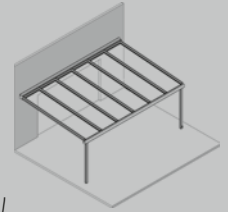

B1 flush, external

B1s as B1, with steel reinforcement (not Murano Puro)

B1v as B1, with Murano Vetro gutter (only Murano Puro)

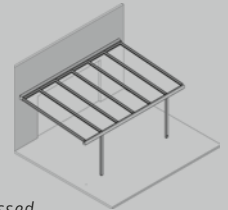

B2 flush, laterally recessed

B2s as B2, with steel reinforcement (not Murano Puro)

B2v as B2, with Murano Vetro gutter (only Murano Puro)

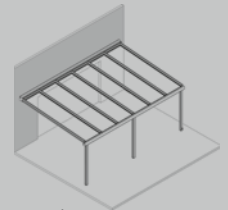

B3 as B1, with 3rd support

B3s as B3, with steel reinforcement (not Murano Puro)

B3v as B3, with Murano Vetro gutter (only Murano Puro)

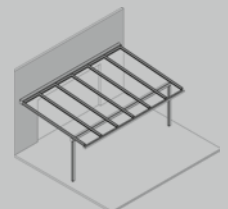

Ü1 rafter overhang, external

Ü1s as Ü1, with steel reinforcement

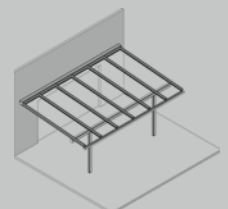

Ü2 rafter overhang, laterally recessed

Ü2s as Ü2, with steel reinforcement

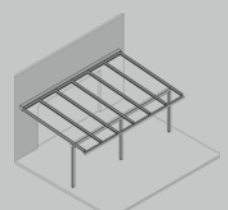

Ü3 as Ü1, with 3rd support

Ü3s as Ü3, with steel reinforcement

Murano Integrale Z

Equipment and technical features

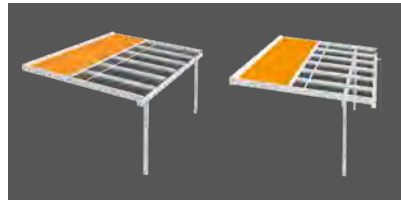

Styles	Flush (B) Type		Overhang (Ü) Type	
	B1, B2	B3	Ü1, Ü2, Ü3	
– Posts laterally external	B1		Ü1	
– Posts laterally recessed	B2		Ü2	
– with 3rd support	B3		Ü3	
– Overhang <i>[inner edge of post – outer edge of gutter]</i>	–		30 - 100 cm	
– Reinforcement: steel (s)	...s		...s	
Fabric guide	ZIP (Z)		ZIP (Z)	
Dimensions (max.)				
Width, 1 unit <i>(single field)</i>	700 cm		700 cm	
Depth <i>(type B: to inner edge of post; type Ü: to outer edge of gutter)</i>	500 cm		500 cm	
Pitch angle, stepless <i>(at least 5° recommended)</i>	3° - 20°		3° - 20°	
Rafter spacings <i>(max., depending on type, roof size, load)</i>	120 cm		120 cm	
Post height 240 cm	■		■	
Longer posts	□		□	
Rainwater drainage				
Downpipe integrated into post	■		–	
Downpipe, external in front of post	–		□	
Water spout <i>(1 item)</i>	–		■	
Glazing				
for laminated safety glass (LSG, clear) or twin-wall sheets	!		!	
Drive				
Electric motor (for wall switch)	■		■	
Radio motor (io)	□		□	
Frame colours				
17 RAL colours + 6 textured finishes <i>(Lewens standard colours)</i>	■		■	
Additional RAL, special colours and effect finishes	□		□	
Awning fabrics from the LEWENS collection				
Branded acrylic <i>(spun-dyed, ultra fade resistant)</i>	■		■	
Branded polyester <i>(spun-dyed, ultra fade resistant)</i>	□		□	
Tenara quality sewing yarn	■		■	
with lateral attachment strip <i>(approx. 15 cm) *</i>	■		■	
Options				
Radio motor + radio remote control (io)	□		□	
Automatic weather sensor (sun, wind, rain)	□		□	
Lighting - LED strips, LED spot bar	□		□	
Radiant heater <i>(only wall attachment)</i>	□		□	
Glass joint	□		□	
Additional drainage <i>(downpipe integrated into post)</i>	□		–	
Rain chain/additional water spout or downpipe	–		□	
Lateral connection profile/various profiles/support frame	□		□	

* On multistripe fabrics, the pattern repeat may be displaced in the area of the attachment strip seam!

Possible dimensions and restrictions along with the complete range of electronic accessories can be found in the technical data in the current Lewens price list.

■ Standard □ Option
– not available

! Not included in scope of supply

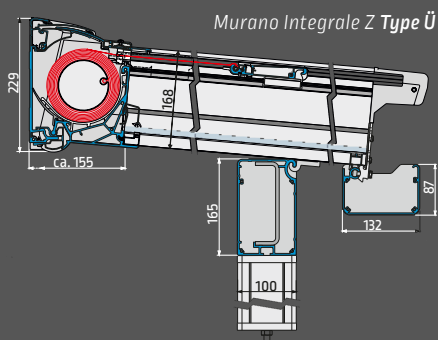
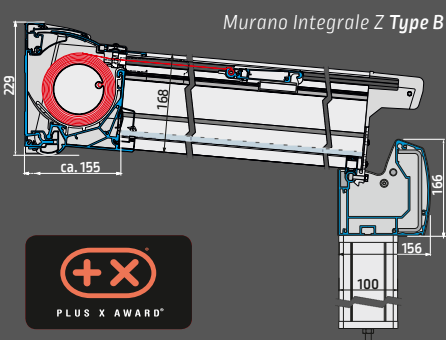

Types and styles

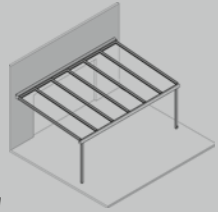

B1 flush, external

B1s as B1, with steel reinforcement (not Murano Puro)

B1v as B1, with Murano Vetro gutter (only Murano Puro)

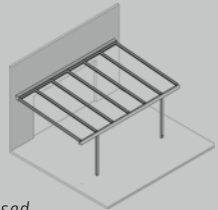

B2 flush, laterally recessed

B2s as B2, with steel reinforcement (not Murano Puro)

B2v as B2, with Murano Vetro gutter (only Murano Puro)

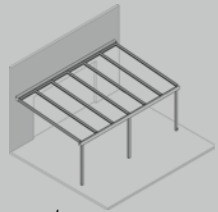

B3 as B1, with 3rd support

B3s as B3, with steel reinforcement (not Murano Puro)

B3v as B3, with Murano Vetro gutter (only Murano Puro)

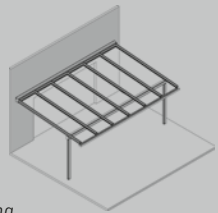

Ü1 rafter overhang, external

Ü1s as Ü1, with steel reinforcement

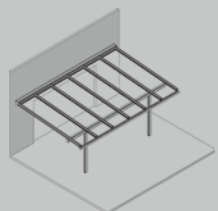

Ü2 rafter overhang, laterally recessed

Ü2s as Ü2, with steel reinforcement

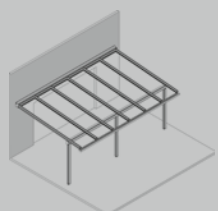

Ü3 as Ü1, with 3rd support

Ü3s as Ü3, with steel reinforcement



Murano Glissando

Equipment and technical features



Manufactured and assembled in Germany
TUV-tested safety
Quality and technology CE-compliant

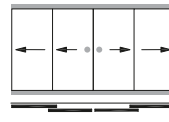
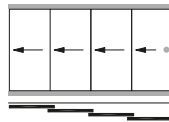

Type	Side-opening	Centre-opening
Number of tracks	2 - 5	2 - 5
Number of panels	2 - 5	4 - 10
Dimensions		
2-track width (max.)	330 cm	540 cm
Number of panels	2	4
3-track width (max.)	470 cm	720 cm
Number of panels	3	6
4-track width (max.)	520 cm	920 cm
Number of panels	4	8
5-track width (max.)	580 cm	1150 cm
Number of panels	5	10
Width of single panels (min./max.)	60 - 130 cm	60 - 130 cm
Overlap of single panels	approx. 5 cm	approx. 5 cm
Height 8 mm toughened safety glass (max.)	230 cm	230 cm
Height 10 mm toughened safety glass (max.)	260 cm	260 cm
Scope of supply (without attachment material)		
Bottom running rail (can be surface-mounted or inset)	■	■
– installation depth bottom running rail (max.)	35 mm	35 mm
– anti-lift device	■	■
Top guide rail + end caps	■	■
Recessed handles (brushed stainless steel, polished, standard h 105 mm)	■	■
Locking mechanism (walk-in panel w. foot lever, stationary panel w. socket screw)	■	■
Glazing (with laminated safety glass, clear in 8 or 10 mm)		
including glass	■	■
without glass with dimension data	□	□
Frame colours		
17 RAL colours + 6 textured finishes (Lewens standard colours)	■	■
Additional RAL, special colours and effect finishes	□	□
Bottom running rail always E6/EV 1 silver anodised	■	■
Top guide rail + end caps in frame colour	■	■
Options		
Lock (handle height, only with wall connection profile)	□	–
Wall connection profile	□	□
Cross member + accessories (for use as side wall)	□	□
Profiles or retainer clips for triangular infill (without glass)	□	□

Possible types

2-track

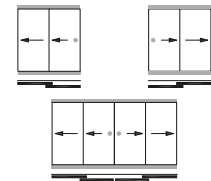

2L or 2R 2 panel

2L+2R 4 panel

3-track

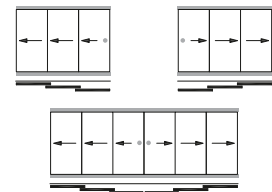

3L or 3R 3 panel

3L+3R 6 panel

4-track

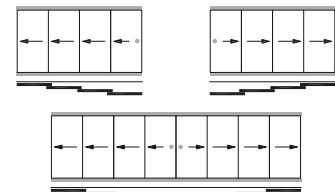

4L or 4R 4 panel

4L+4R 8 panel

5-track

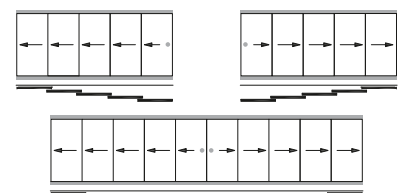

5L or 5R 5 panel

5L+5R 10 panel

Possible dimensions and restrictions along with the complete range of electronic accessories can be found in the technical data in the current Lewens price list.

■ Standard □ Option
– not available

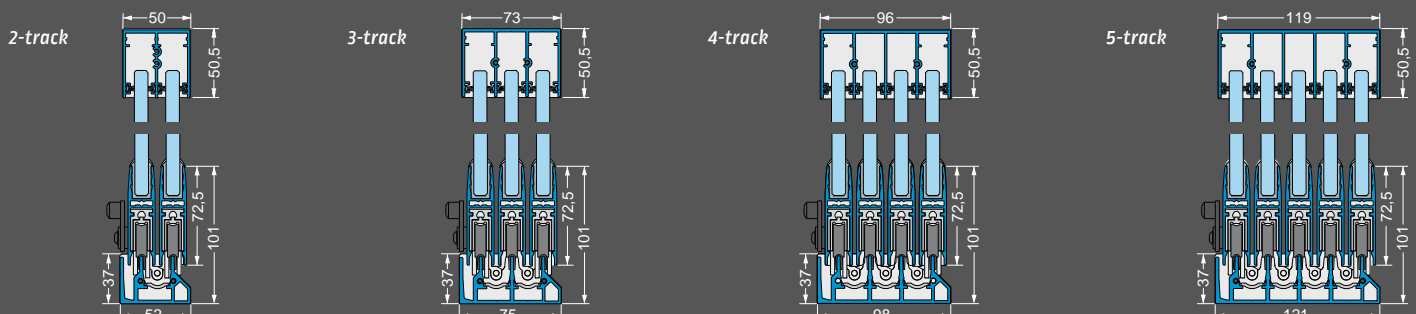

Murano Finestra

Equipment and technical features

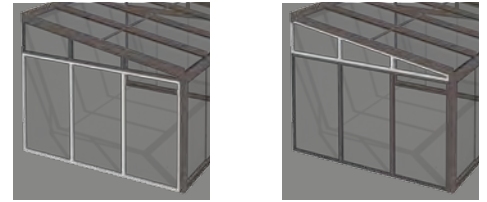

Manufactured and assembled in Germany
Quality and technology CE-compliant

Type	Rectangle	Inclined section
With uprights	■	■
Number of uprights	Width-dependent (acc. to max. single panel width)	
Dimensions		
Width (max.)	500 cm	500 cm
Width of single panels (max.)	120 cm	120 cm
Height (max.)	230 cm	230 cm
Glazing		
without glass (with dimensions, prepared for 8 or 10 mm ESG or VSG)	■	■
Frame colours		
17 RAL colours + 6 textured finishes (Lewens standard colours)	■	■
Additional RAL, special colours and effect finishes	□	□
Equipment		
Drainage slots	■	■
Options		
Extra upright	□	□
Connection profile for Murano glass roof rafters	-	□
Attachment set for Murano glass roof rafters	-	□
Connection of rectangular and inclined section elements factory prepared (full glazing)	□	□
Reinforcement profile for full glazing (recommended above 300 cm width due to wind load)	-	□
Wall connection profile	□	□
Finishing profile	□	□

Possible dimensions and restrictions along with the complete range of electronic accessories can be found in the technical data in the current Lewens price list.

■ Standard □ Option - not available

Possible types and applications

Rectangle

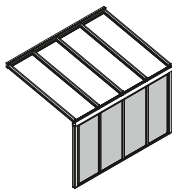

Glass roof front

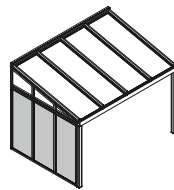

Glass roof side(s)

Inclined section

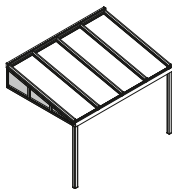

Side wall triangular infill

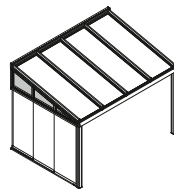

+ Glissando sliding glass panels

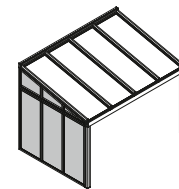

+ rectangle = full glazing

Section

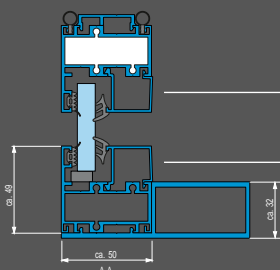

Glass retaining strip

Glass retaining strip

Reinforcement profile
(above 300 cm width)

Detail

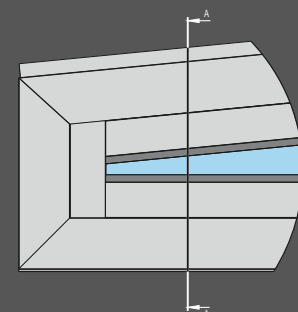

Vertical awning

Micro 2020

Type



Angular



Fabric guide

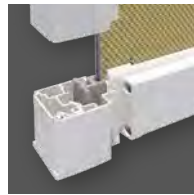

ZIP guide(Z)
Track with fabric guide

Equipment

for large single units

for all Murano glass roofs

Cassette flush with wall

Cassette, H x D approx. 110 x 113 mm

Fabric

Screen

Height max. 270 cm

Acrylic/Polyester

Height max. 220 cm

Width 1 unit max. 600 cm

Drive Motor

Standard Option

Options

- Radio motor + radio remote control
- Automatic weather sensor



Murano Integrale
with Micro 2020 and Micro 700

Vertical awning

Micro 4000

Type



Angular

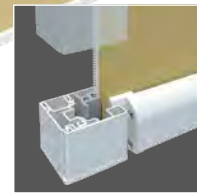

Fabric guide: ZIP guide(Z)
Track with fabric guide

Equipment

for large single units

for Murano Overhang type glass roofs

Cassette flush with wall

Cassette, H x T approx. 145 x 160 mm

Fabric

Screen

Window awnings

Width 1 unit * max. 600 cm

Height ** max. 600 cm

Drive Motor

Standard Option * up to height 300 cm max.
** up to width 300 cm max.

Options

- Radio motor + radio remote control
- Automatic weather sensor



Murano Integrale Type U1
with Micro 4000

TO MATCH:

Glass roof awning

Ancona

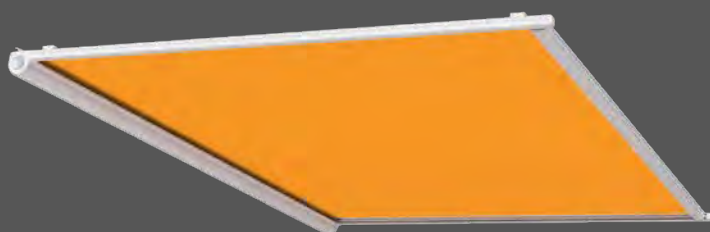

Glass roof awning

Portofino

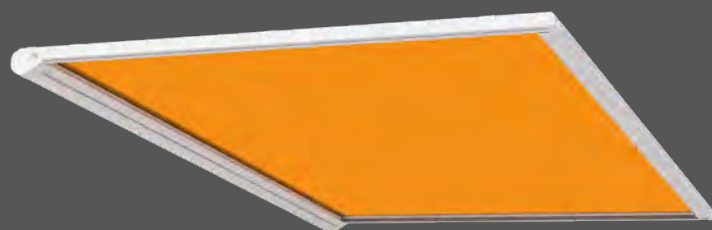

GDA GESAMTVERBAND DER ALUMINIUMINDUSTRIE e.V.
Aluminium-Profil-Award

Types



Interior

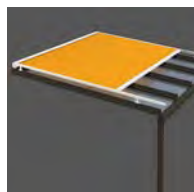

Roof-mounted (incl. roof cover)

Equipment

Cassette

for conservatory / glass roof

Interior or roof-mounted installation

Width 1 unit max. 600 cm

Drop max. 450 cm

Drive Motor ■

■ Standard

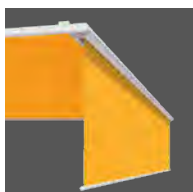

Options

- Radio motor + radio remote control
- Automatic weather sensor
- Fabric support wire
- Interior type: **roof cover**
- Interior type: **Vario Valance**



Type

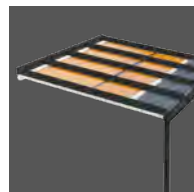

Interior

Fabric guide



ZIP guide(Z)

Track with fabric guide

Equipment

Cassette

for conservatory / glass roof

Width 1 unit max. 600 cm

Drop max. 500 cm

Drive Motor ■

■ Standard



Options

- Radio motor + radio remote control
- Automatic weather sensor
- LED strip integrated in casing
- LED profile under guide tracks
- Vario Valance



Glass roof awning

Capri

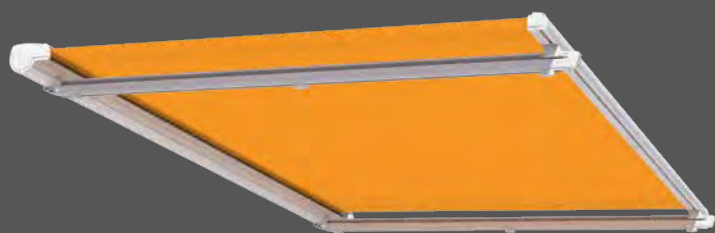

Side screen awning

Micro 700



Type

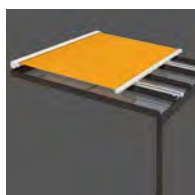

Roof-mounted

Equipment

Cassette
for conservatory / glass roof

Width 1 unit max. 700 cm

Joined system max. 1200 cm

Drop max. 600 cm

Drive Motor

Standard

Options

- Radio motor + radio remote control
- Automatic weather sensor
- Extra fabric support



Type



Equipment

Side screen awning

Wall cassette

Screen height up to max. 250 cm

Extension, depending on height and fabric max. 400 cm

Attachment

Wall bracket

Post

Drive Manual operation

Fabric

Acrylic/Soltis 92

Polyester

Standard Option

Options

- additional handles

Further information

can be found in the "Glass Roof Awnings",
"Façade Awnings" and "Micro 700" brochures.



www.lewens-markisen.de



Your stockist will be happy to advise you: